



MADE FOR YOU BY SANREMO

THE NEW SINGLE GROUP MULTI-BOILER MACHINE,
NOT ONLY FOR THE PROFESSIONAL MARKET

Designed to allow total control of the extraction parameters and then... it's all up to you.

YOU was born to be more than a professional tool.

It is a personal assistant, thanks to the possibility of creating manual settings and saving them by inventing original recipes.

Inspiring you to continue to experiment, improve, dare.



YOU WORK
YOU STRIVE
YOU GIVE
YOU NEED
YOU CREATE
YOU FEEL
YOU INSPIRE

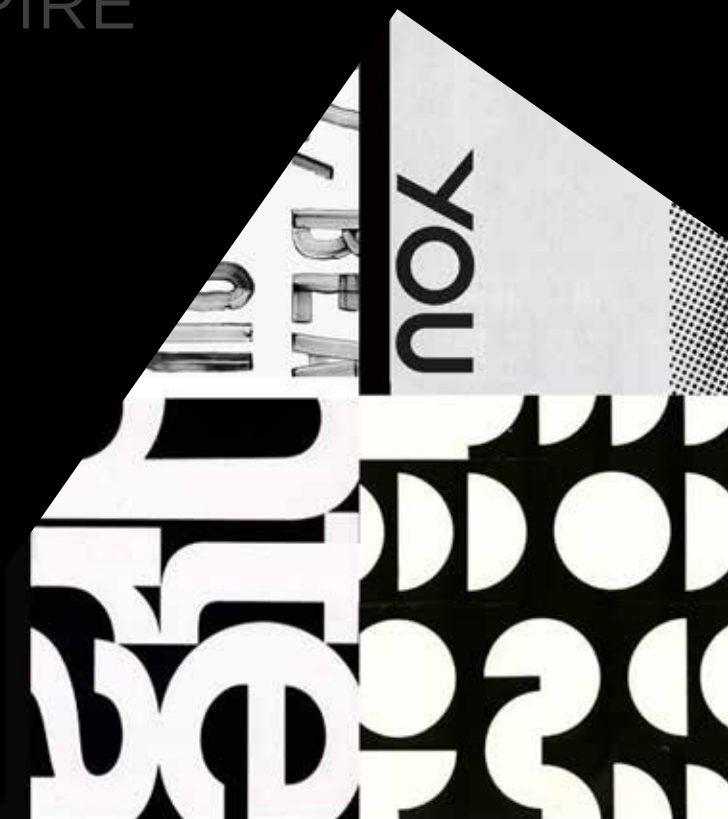

YOU PUSH
YOU FEEL
YOU CREATE
YOU INSPIRE
YOU WANT
YOU LOVE
YOU PLAN
YOU COMPETE
YOU LIVE



YOU WORK

COMPLETE RELIABILITY FROM THE SANREMO GROUP

MULTI-BOILER

Both boilers, coffee and services, are in **AISI 316 stainless steel**.

3 CONFIGURATIONS

- _ with **tank**
- _ with **connection to the water mains**
- _ full with **both possibilities**

CUSTOMIZABLE PRESETS

Extraction profiles customizable and storable:

- _ **6 standard profiles** with optimal parameters presets
- _ **12 profiles completely customizable** by intervening in all 3 extraction phases, and with the ability to totally disable pre-infusion and post-infusion
- _ your **settable manual profiles directly from the Paddle**



USER-FRIENDLY

The **touch-screen display is intuitive** with inspired navigation menus to the smartphone APPs.

- _ **Quick menu:** choose three extraction profiles which can be accessed with a single touch.
- _ **General menu:** all functions are easily reachable, even washing and technical assistance.

VOLUMETRIC PUMP



New generation of 70 liters which **allows profiling**.

YOU PLAY



FRESH WATER

Instant freshly heated water for higher quality infusions.



Small tank size to **avoid prolonged water stay** and to improve the total quality of the final product.



ENERGY EFFICIENCY

Thanks to two eco / on-off modes:

Automatic allows you to select 6 bands hourly daily / weekly.

Manual allows you to switch off and on the machine manually or individual boilers.



SPEED AND ERGONOMICS

Start / Stop levers to activate water and steam with just one click.

Steam and water wands Cold Touch



USB ENTRANCE



For software updates and loading profiles.

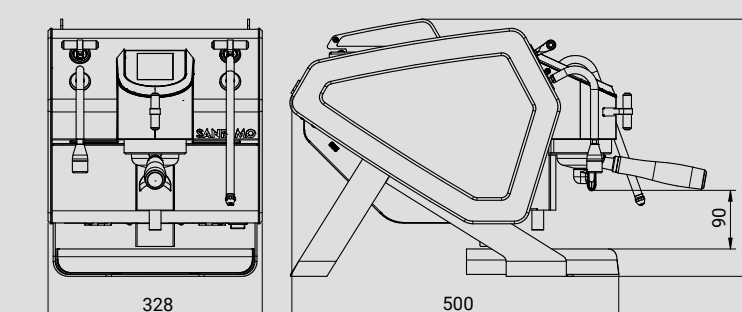

TECHNICAL DATA

Voltage	Version 1	220-240V
	Version 2	110-120V
	Version 3	100V / 50-60 Hz
Power consumption	2.35 kW	
Steam boiler capacity	1 lt	
Steam boiler resistance power	1.5 kW	
Coffee boiler capacity	0.5 lt	
Coffee boiler resistance power	500 W	
Net weight	32 kg	

VERSIONS

Black	matt / glossy (frames)	RAL 9005
White	matt / glossy (frames)	RAL 9003
	legs and sides	RAL 8019
Custom	sides, lever knobs, paddle lever	veneered wood

YOU CREATE

CONSTANT STABILITY

Even after prolonged dispensing, thanks to the **electronic control of pressure and temperature**.

YOU ARE IN CONTROL

1. Thanks to the **front lever (Paddle)** you can change the pressure however you like instantly creating curve custom settings.
2. Monitor the **extraction in real time on the display**.
3. **Memorise your favourite settings** to retrieve them whenever you want.

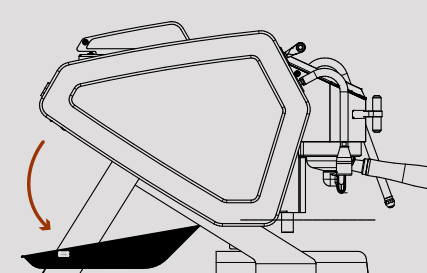

EASY SERVICE

The flap opening on the back allows for easy maintenance of the electronic components.



Total Black



Total White



Black and White



Choose the cover to customize

Kit_Panels_Wood_ The kit includes 2 magnetic sides panels with a finish

Total Black



Total White



Black and White

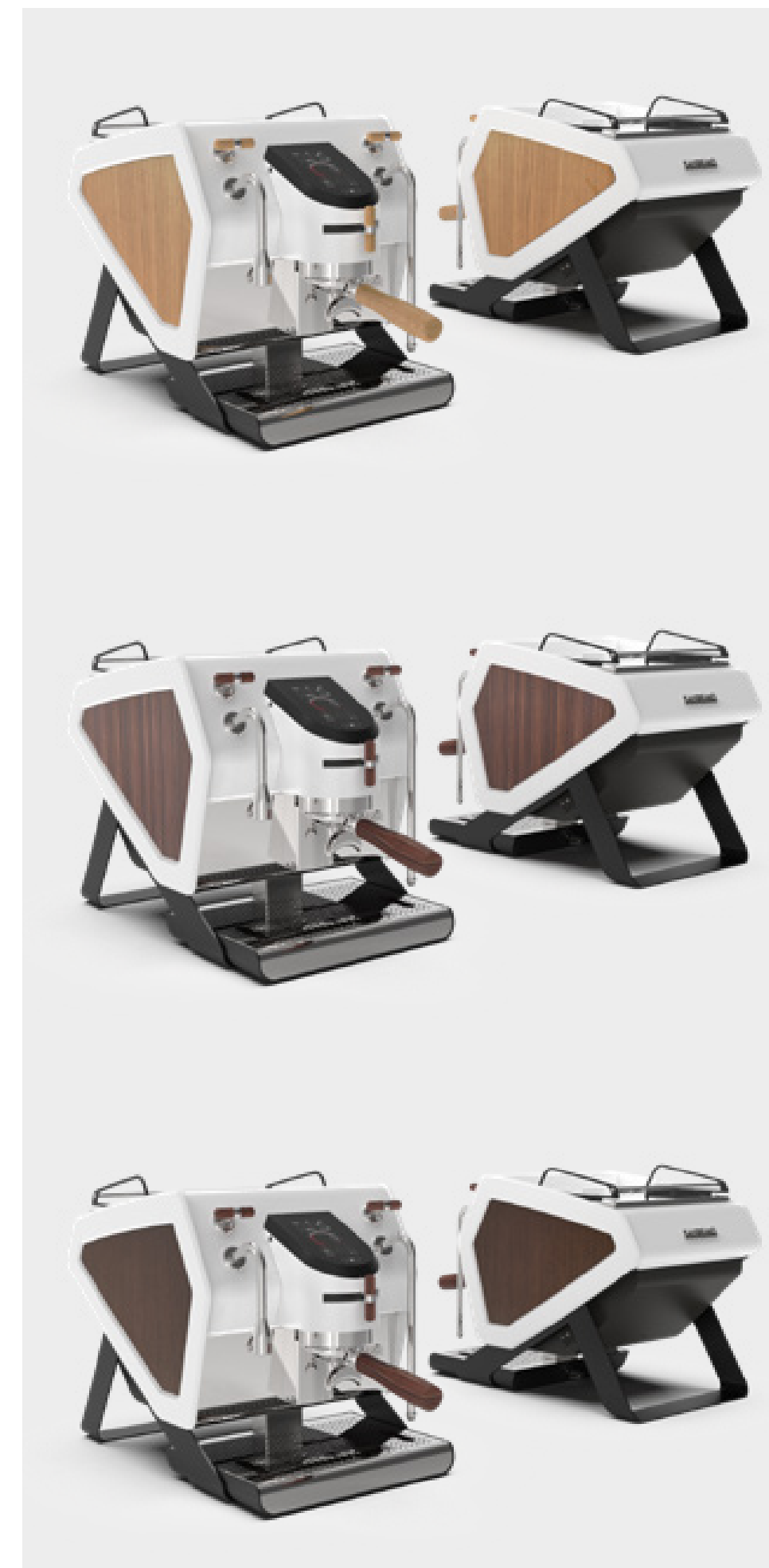

Finishes



Kit_Accessories_filter holder and knobs_ The kit includes 1 filter holder and 3 knobs with a finish chosen from the following

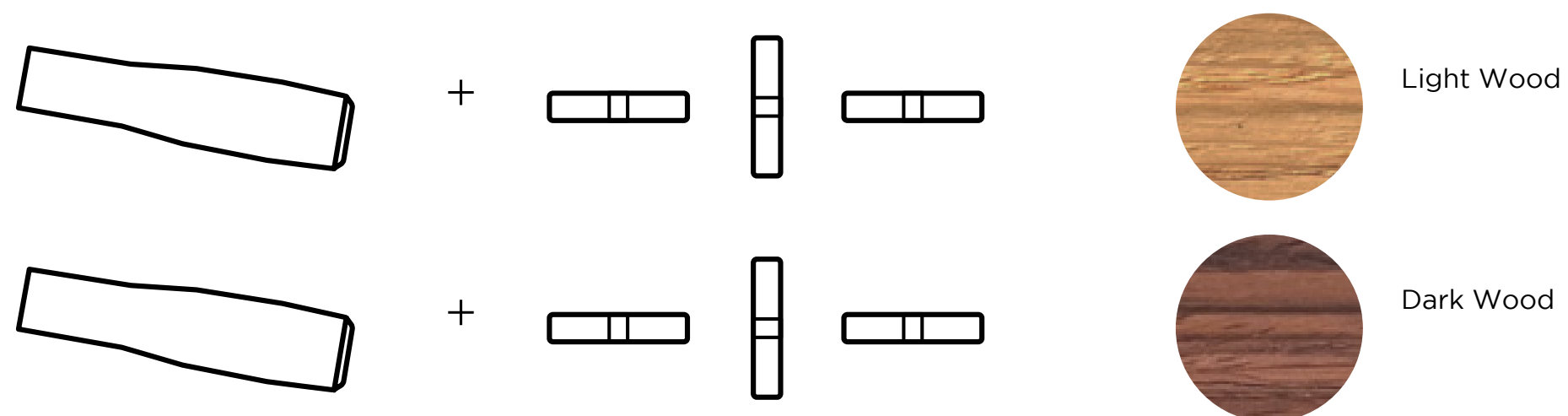

Wood

Kit_Panels_Leather_ The kit includes 2 magnetic sides panels with a finish

Total Black



Total White



Black and White



Finishes

Mouse

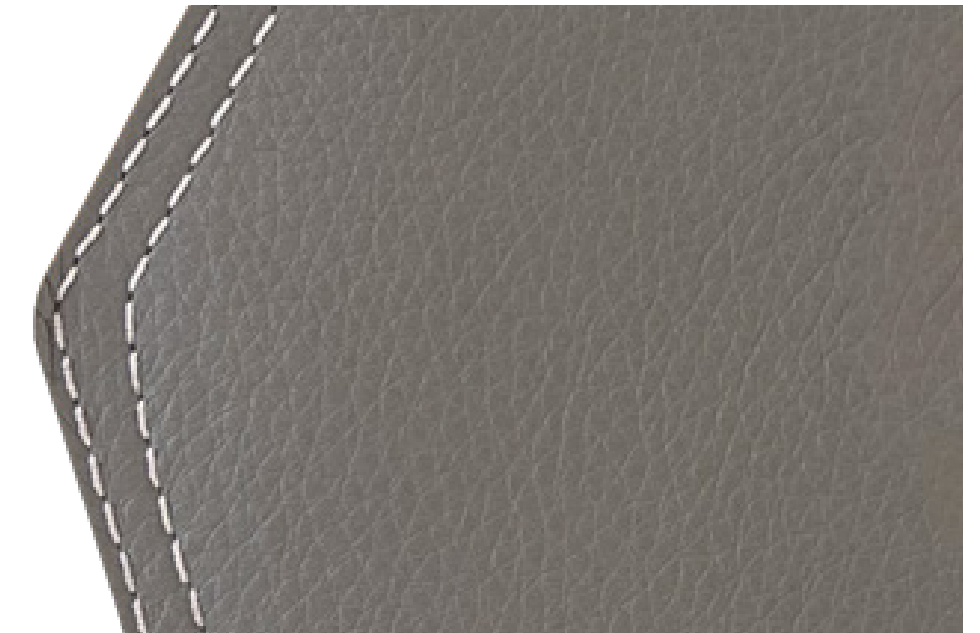

Taupé

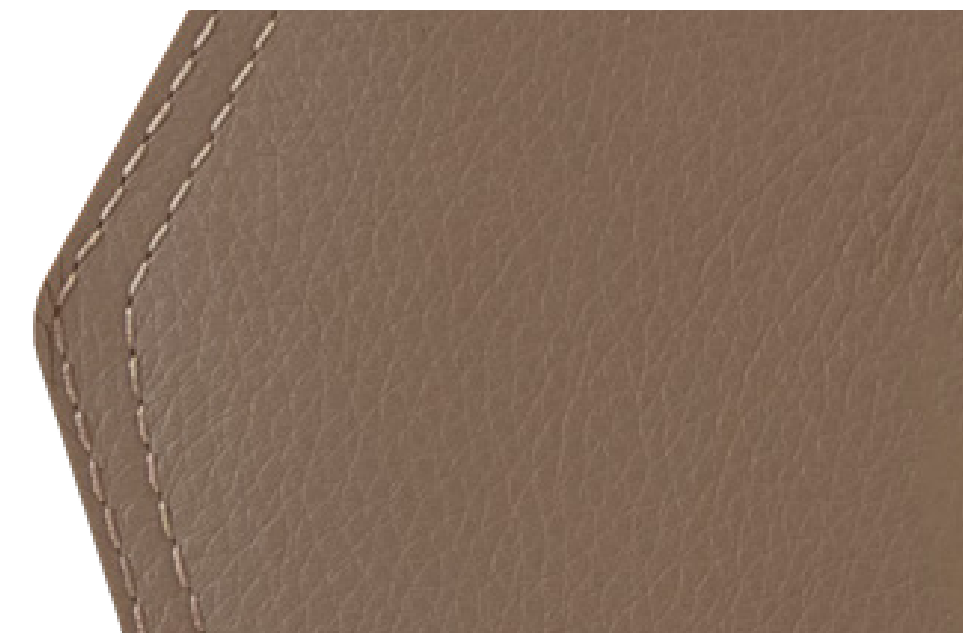

Ebony

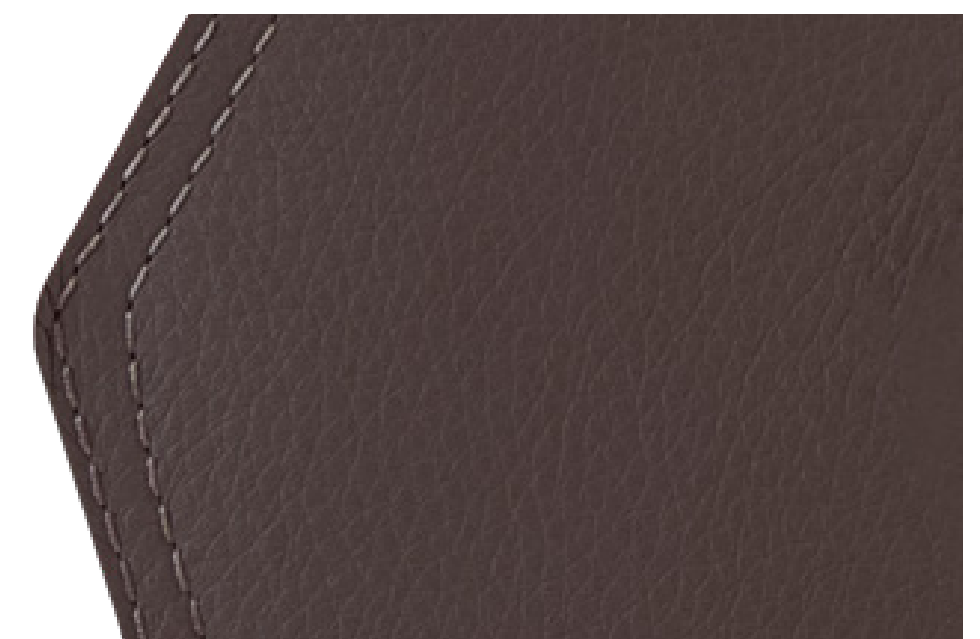

Kit_Accessories_filter holder and knobs_ The kit includes 1 filter holder and 3 knobs with a finish chosen from the following

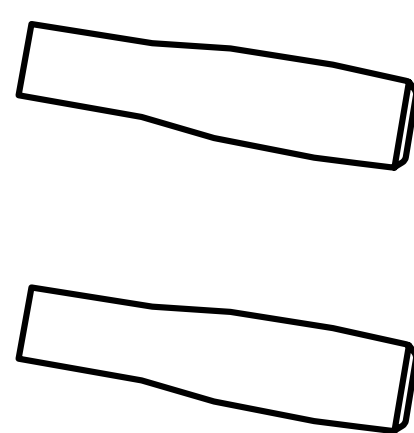

+

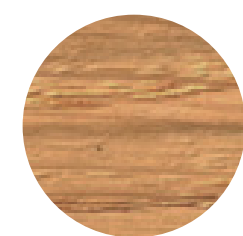
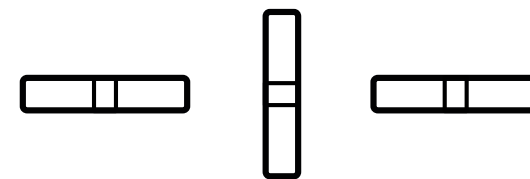

Light Wood

+

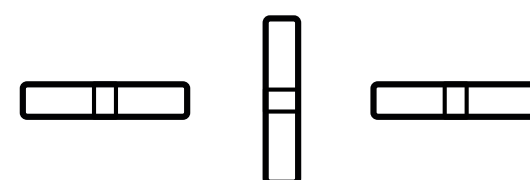

Dark Wood

Leather

REACH US

Mobile number: +966 53 885 9093

Website: www.rfa-sa.com , <https://sanremosaudiArabia.com/>

Online shop: <https://shop.rfa-sa.com/>

Email: customer-service@rfa-sa.com

Location: Al Thumama, Riyadh, Saudi Arabia

